



SUBARU



CROSSTREK

Designed for Fun. Built for Action.

From joy rides in the city to active outdoor adventures, the Crosstrek adds more fun to every drive, every time. The sharp and dynamic design with a powerful front face and overhanging fenders is fun—even just to look at. Equipped with the latest Subaru safety technologies for peace of mind on any road, the Crosstrek's improved driving dynamics provide uncompromising comfort from the day-to-day to the extraordinary.



Fits Any Size Adventure

Load your gear and enjoy all your favourite activities. The Crosstrek keeps things playful with a versatile cargo space that's easy to use for any purpose. When open, the rear gate provides ample overhead space with a convenient handle position that's easy to reach. Inside, convenient cargo hooks on both sides help secure luggage or hang small items to keep the area organised.



Rear Gate Trim / Side Sill Plate

The rear gate trim and rear door side sill plates feature a non-slip, scratch-resistant texture with a mountain range motif design that connect seamlessly to create a harmonious and playful atmosphere that's also functional. Plus, the expanded side sill plates provide convenient roof rail access for anyone.



60/40-split Folding Rear Seats

Easily store longer items with the versatile folding rear seat backs.

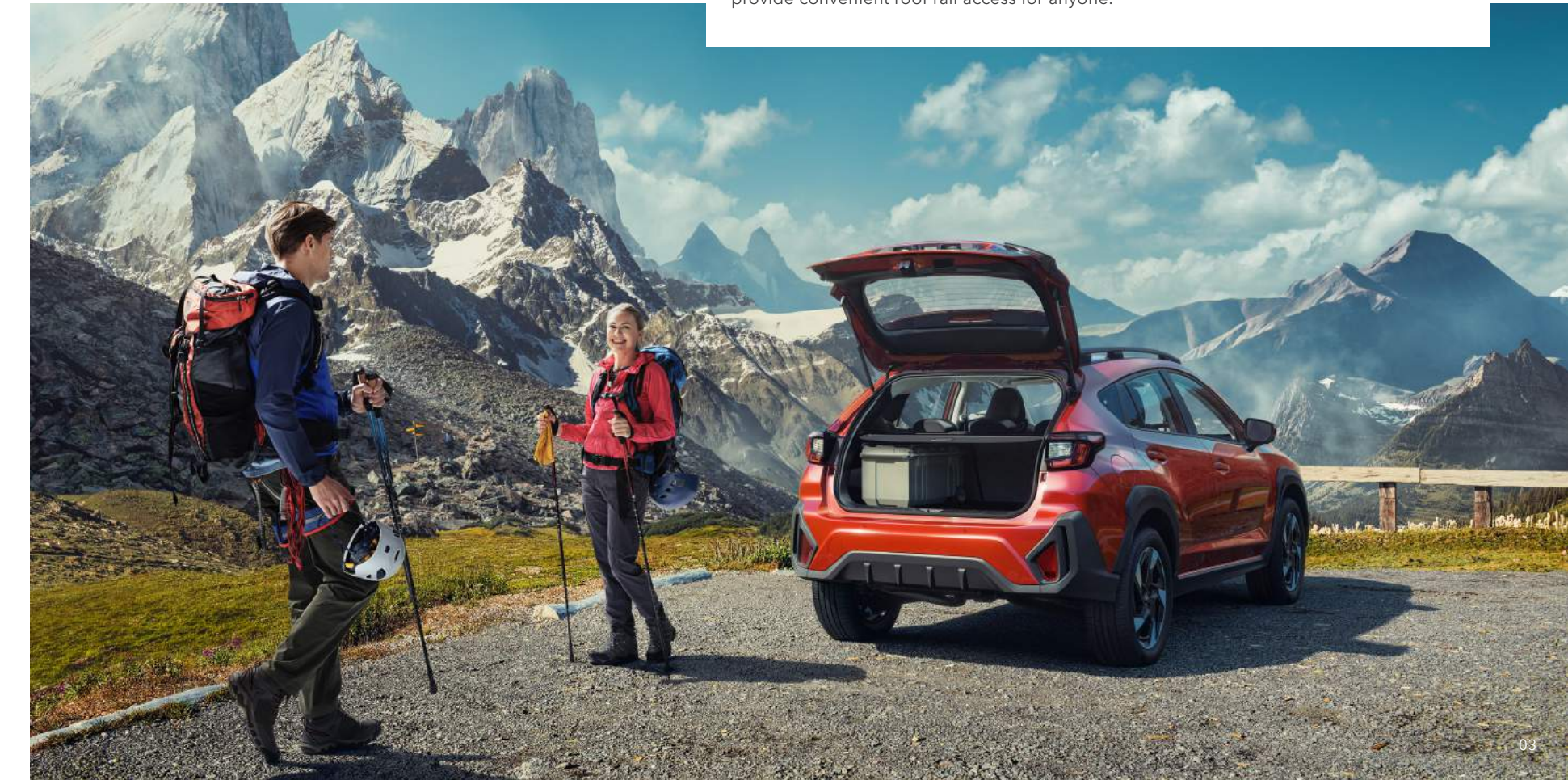

Where the Fun Starts

Bring the comforts of your daily life along in the Crosstrek. Listen to music, check your messages, or talk on the phone with the touchscreen display and latest infotainment system as you comfortably reach any destination. Conveniences like Qi compatible wireless charging*¹*² for your smartphone and more intuitive air conditioning controls help make your drive more enjoyable.

*¹ Optional.
*² Qi wireless charging may not be compatible with all mobile phones.
*³ Apple CarPlay is a trademark of Apple Inc., registered in the U.S. and other countries.
*⁴ Android and Android Auto are trademarks of Google Inc.
Apple CarPlay and/or Android Auto may not be available for all models and regions. Please contact your local authorised Subaru retailer for more details.
Driver is always responsible for safe and attentive driving. Please refrain from operating the touchscreen while driving.



11.6-inch Centre Display*¹

The large 11.6-inch touchscreen display allows intuitive, smartphone-like operation for audio and other useful functions, while supporting a wide range of infotainment features such as Apple CarPlay*³ and Android Auto*⁴.



Wireless Charger*¹*²

Charge your smartphone or other Qi compatible electronic devices. Placed in the instrument panel centre tray that's easy to access, it provides up to 10W of power for rapid charging.



Fun, Functional, and Enjoyable for All

Inside the Crosstrek, you'll discover a place where all your passengers can share an enjoyable and fulfilling time together. The front seats, based on the latest medical research on sources of ride discomfort to the human body, are designed to firmly support the pelvis for outstanding comfort during acceleration, steering, and on rough roads. What's more, excellent vibration absorption minimises unwanted interior noise for a safe and enjoyable driving experience to all passengers, even on long rides.



10-way Power Driver's Seat*

The 10-way power driver's seat with a 2-way power lumbar support encourages a natural and comfortable driving posture for comfort on long drives.

* Optional.



Console Box

Conveniently secure smaller items in the wider and larger-capacity console box.



No Adventure Too Tough

Any destination is a comfortable and casual ride away in the Crosstrek. Symmetrical All-Wheel Drive and improved driving dynamics provide a safe and enjoyable time for everyone on board, even on rough roads. Plus, you'll have complete peace of mind knowing getting unstuck from dirt, snow, or mud is easy with the evolved X-MODE.

* Dual-function X-MODE only available in premium models.

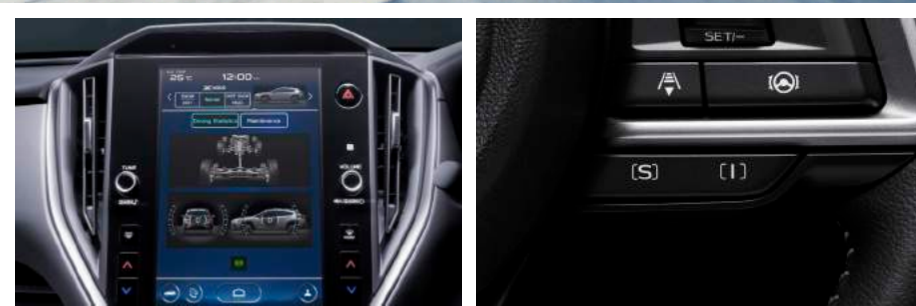

Dual-function X-MODE*

Unlock your vehicle's true driving potential with dual-function X-MODE. Conveniently switch between [SNOW/DIRT] or [D.SNOW/MUD] mode via the 11.6-inch touchscreen to suit the road condition.

SI-DRIVE

Based on your driving style, Subaru Intelligent Drive (SI-DRIVE) can adjust engine response to give you immediate power and agility when you crave it in nearly any scenario.

SUBARU e-BOXER

From daily driving to wild outdoor adventures, SUBARU e-BOXER provides an environmentally friendly drive that's sporty yet comfortable and quiet, even on rough roads. The more powerful new-generation SUBARU e-BOXER combines the SUBARU BOXER engine with an electric motor for powerful, immediate torque and responsive, natural-feeling acceleration.



SUBARU BOXER Engine + Electric Technology

For efficient driving, the SUBARU e-BOXER system adjusts the power-split ratio between the dedicated 2.0-litre direct-injection engine and the electric motor to match the driving condition. When paired with Lineartronic, the result is quiet, smooth, and powerful performance for a comfortable and enjoyable drive in many situations. What's more, the motor and battery's longitudinal placement along the vehicle's centreline complements the vehicle's stability and balance it gets from the low centre of gravity SUBARU BOXER engine and inherently stable Symmetrical AWD design.



SUBARU CORE TECHNOLOGY

The Subaru Difference

Subaru's core technologies identify the Subaru brand and give you the unique driving feel you can find only in a Subaru. These core systems allow Subaru vehicles to live up to its standards in performance, comfort, safety, and reliability while keeping its promise to deliver enjoyment and peace of mind to all passengers.



Lineartronic + Active Torque Split AWD

Lineartronic adjusts to any ratio in its range for smooth and stepless gear changes that keep the engine in its most efficient range for efficient and smooth acceleration, driving performance and better fuel efficiency. It comes paired with Subaru's active torque split AWD system. Its default torque is well-balanced front to rear and adjusts in response to real-time traction conditions.

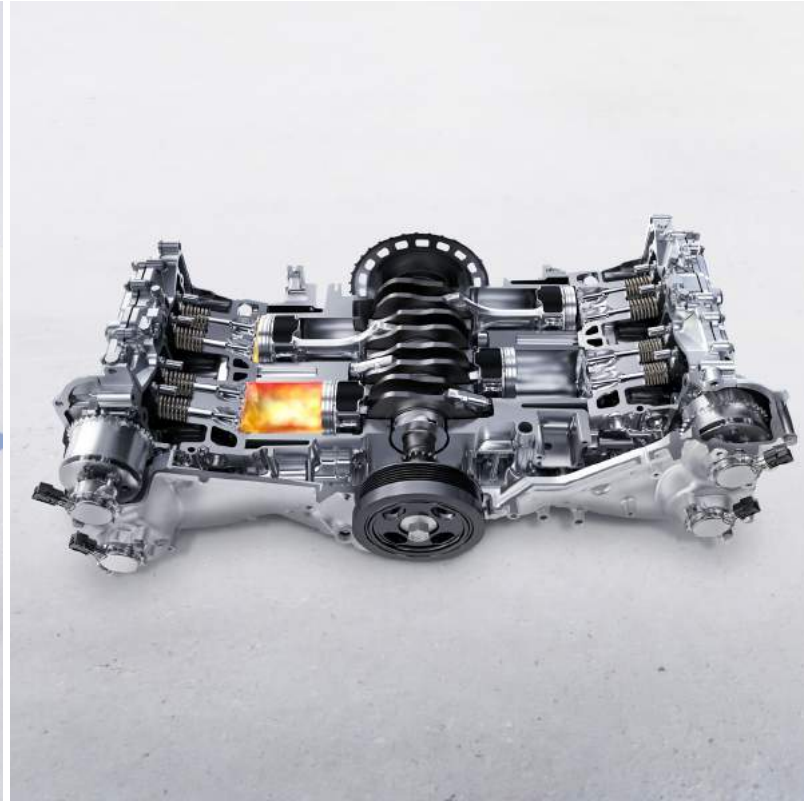

SUBARU BOXER Engine

A boxer engine, or a horizontally opposed engine, is an engine configuration in which its pistons move toward each other in a horizontal direction. Subaru has been solely committed to the SUBARU BOXER engine for its many advantages over other engine types, providing durability and reliable performance in its vehicles.

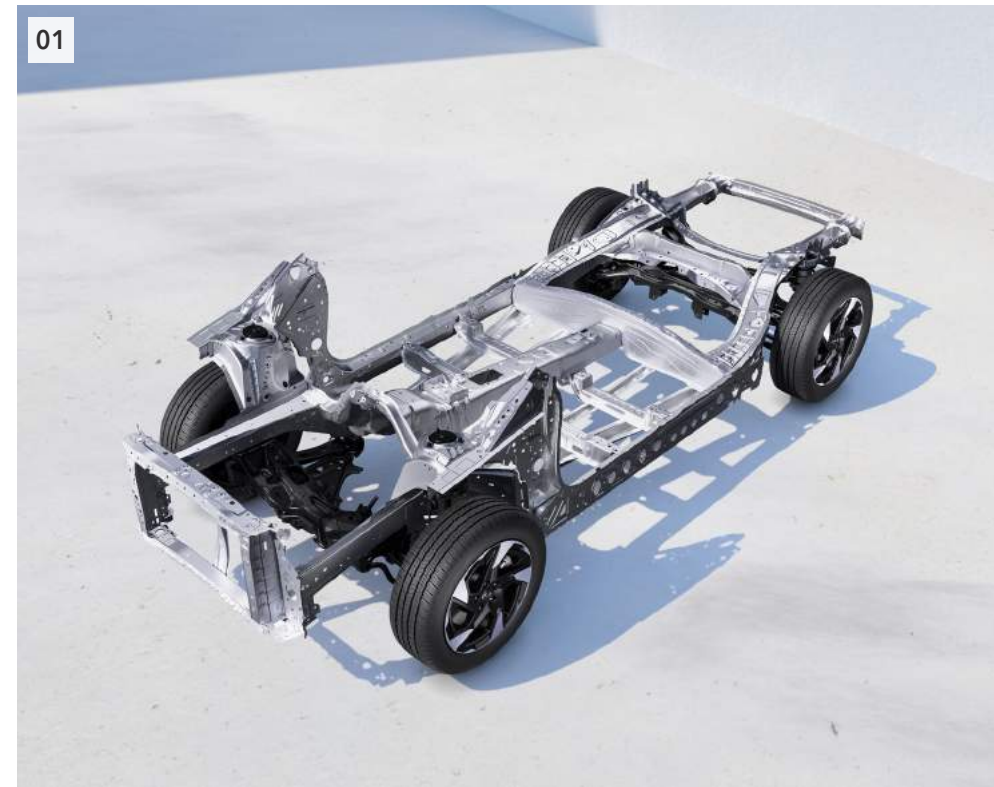

01 Subaru Global Platform

The latest technologies added to the evolved Subaru Global Platform and a full inner frame structure, together with Subaru's AWD system, provide all passengers with even greater enjoyment and peace of mind. Thanks to improvements in the use of structural adhesives and rigidity of suspension mounting points, overall driving dynamics are greatly enhanced so everyone can spend an enjoyable and fulfilling time together.



02 Driver Monitoring System*

Driver Monitoring System is a state-of-the-art safety support system that utilises a dedicated camera and facial recognition software to monitor fatigue or lack of attention. It recognises up to five pre-registered drivers to provide customised driver settings for a comfortable, convenient, and personalised driving experience.



03 Full Inner Frame Structure

A full inner frame construction and wider structural adhesive use help reduce sudden body movements while driving. A unified feel of steering and vehicle movement provide better driving dynamics and stability on any road.

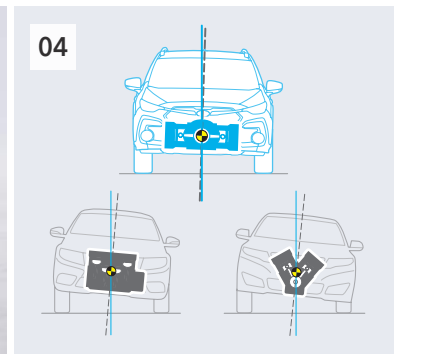

04 Naturally Balanced

The engine's flat design is inherently rigid and self-balancing, generating less vibration than other engine types.

* Optional.



Class-leading Confidence

The Crosstrek's latest safety systems provide anyone—from newer drivers to the more experienced—with fun and confident driving in any situation. In addition to the new-generation EyeSight*¹, driver support features like the LED cornering lamps*² and Multi View Monitor*² make driving more comfortable and stress-free.

*¹ EyeSight is a driving support system which may not operate optimally under all driving conditions. The driver is always responsible for safe and attentive driving and observance of traffic regulations. System effectiveness depends on many factors such as vehicle maintenance, weather, and road conditions. See Owner's Manual for complete details on system operation and limitations for EyeSight including functions in this brochure.
*² Optional.



Wide-angle Monocular Camera*²

An additional wide-angle monocular camera works with the dual-camera system for improved detection of pedestrians and bicycles at low speeds.

*³ Pre-Collision Braking System may not work in all situations. Depending on the speed difference from objects, the object's height, and other conditions, every situation may not meet the necessary conditions for EyeSight to work optimally.
*⁴ Effective when used in conjunction with seatbelts.
The driver is always responsible for safe and attentive driving and observance of traffic regulations. Please do not depend solely on these safety features for safe driving. There are limitations to the features of this system. See Owner's Manual for complete details on system operation and limitations. Please ask your retailer for more details.

EyeSight Driver Assist Features



Adaptive Cruise Control

Can look ahead and help automatically adjust your speed and distance from the vehicle ahead, a convenience in stop-and-go traffic.



Lane Centring Control and Preceding Vehicle Adaptive Steering Control

Can reduce driving fatigue with improved preceding vehicle recognition accuracy that allows cruise control to continue working even around sharp turns.



Pre-Collision Braking System*³

Can warn you with a buzzer and flashing indicator when it senses an impending front collision, and even intervene to prevent the collision or reduce any impact.



Autonomous Emergency Steering*²

Can help avoid a collision with automatic steering support when it detects lane markings to judge if there is enough space to safely avoid a frontal collision.

Other Driver Assist Features:

Lane Departure Prevention / Pre-Collision Throttle Management / Lead Vehicle Start Alert / EyeSight Assist Monitor*²

Standard Safety Features



Reverse Automatic Braking (RAB)*²

Four sensors on the rear bumper detect obstructions behind the vehicle when reversing. If detected, the system can alert the driver with warning sounds and automatically apply the brakes to avoid a collision or reduce collision damage.



Supplemental Restraint System (SRS)*⁴ Airbags

Front SRS*⁴ airbags, front side SRS*⁴ airbags, curtain SRS*⁴ airbags, a knee SRS*⁴ airbag, and a seat cushion SRS*⁴ airbag come standard to give all passengers a higher level of protection in the event of a collision.



Hazard Avoidance

Made possible by the Subaru Global Platform, the lower centre of gravity design, enhanced suspension system, and rigidity improvements provide a vehicle that responds immediately when evasive actions are taken, helping avoid hazards on the road.



LED Cornering Lamps*²

The LED cornering lamps help prevent nighttime accidents at intersections. When turning left or right, they provide bright illumination of the area ahead towards the direction of travel, helping detect pedestrians and bicycles early.

Other Safety Features:

High Visibility / Subaru Rear Vehicle Detection (SRVD)*² / High Beam Assist (HBA)*² / Steering Responsive Headlights (SRH)*² / Auto Vehicle Hold / Vehicle Dynamics Control System + Active Torque Vectoring / Cabin-Protecting Layout / Ring-Shaped Reinforcement Frame

LINEUP

CROSSTREK 2.0i-S EyeSight / 2.0i-L EyeSight

DIMENSIONS..... L x W x H: 4480 x 1800 x 1600 mm
 POWER UNIT..... Horizontally opposed, 4-cylinder, 2.0L DOHC 16-valve + Motor
 CAPACITY..... 1995 cc
 MAX OUTPUT..... SUBARU BOXER Engine: 110 kW (150 PS) / 5,800 - 6,000 rpm
 Motor: 12.3 kW (16.7 PS)
 MAX TORQUE..... SUBARU BOXER Engine: 196 Nm (20.0 kgfm) / 4,000 rpm
 Motor: 66 Nm (6.7 kgfm)
 TRANSMISSION..... Lineartronic, AWD



Oasis Blue

CROSSTREK 2.5i-S EyeSight

DIMENSIONS..... L x W x H: 4480 x 1800 x 1600 mm
 ENGINE..... Horizontally opposed, 4-cylinder, 2.5L DOHC 16-valve, petrol
 CAPACITY..... 2498 cc
 MAX OUTPUT..... 124 kW (169 PS) / 5,000 - 5,800 rpm
 MAX TORQUE..... 252 Nm (25.7 kgfm) / 3,800 rpm
 TRANSMISSION..... Lineartronic, AWD



Sapphire Blue Pearl

CROSSTREK 2.0i-S EyeSight

DIMENSIONS..... L x W x H: 4480 x 1800 x 1600 mm
 ENGINE..... Horizontally opposed, 4-cylinder, 2.0L DOHC 16-valve, petrol
 CAPACITY..... 1995 cc
 MAX OUTPUT..... 115 kW (156 PS) / 6,000 rpm
 MAX TORQUE..... 196 Nm (20.0 kgfm) / 4,000 rpm
 TRANSMISSION..... Lineartronic, AWD



Offshore Blue Metallic

CROSSTREK 2.0i-L EyeSight / 2.0i-L

DIMENSIONS..... L x W x H: 4480 x 1800 x 1600 mm
 ENGINE..... Horizontally opposed, 4-cylinder, 2.0L DOHC 16-valve, petrol
 CAPACITY..... 1995 cc
 MAX OUTPUT..... 115 kW (156 PS) / 6,000 rpm
 MAX TORQUE..... 196 Nm (20.0 kgfm) / 4,000 rpm
 TRANSMISSION..... Lineartronic, AWD



Sun Blaze Pearl



FEATURES

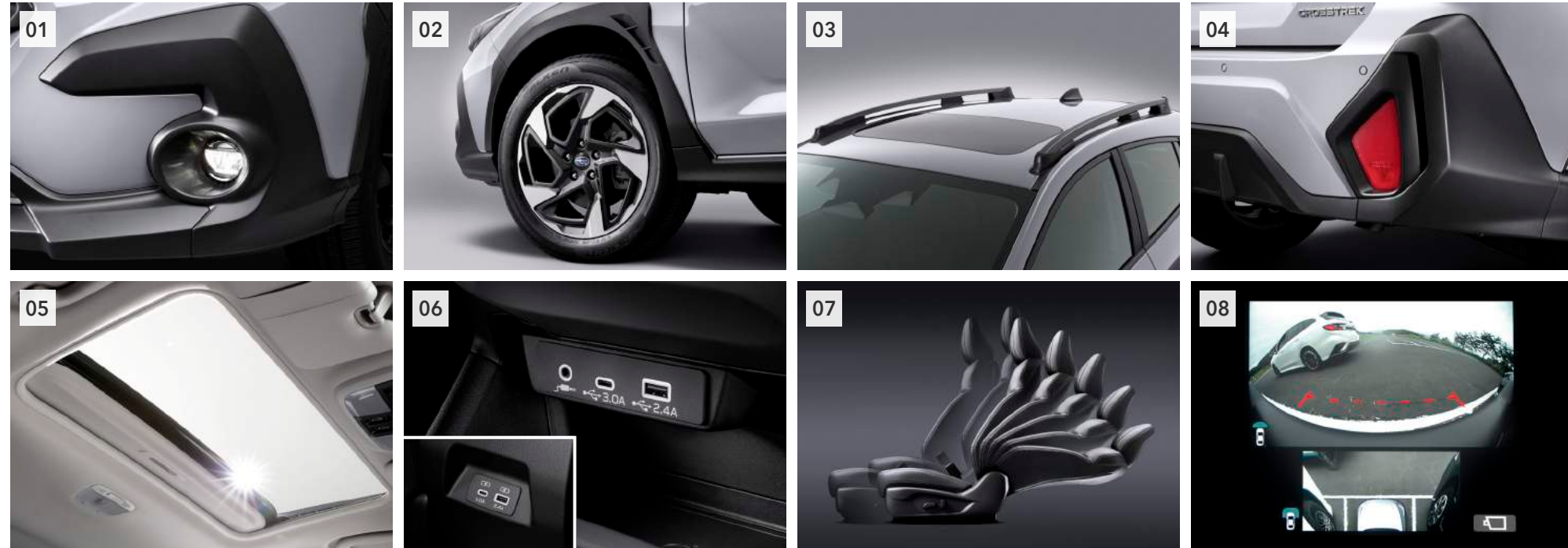

01 LED Front Fog Lamps*

These LED fog lamps have inner reflective surfaces that were adjusted for enhanced visibility and improved safety during nighttime driving.

02 18-inch Aluminium-alloy Wheels*

The thick spoke design creates a fun and sporty look.

03 Roof Rails

The redesigned and expanded roof rails with larger rail covers are easy to access for anybody and give the vehicle a tough SUV look.

04 LED Rear Fog Lamp*

Useful in reduced visibility due to fog, snow, smoke, or dust.

05 Power-sliding, Tilt-adjustable Glass Sunroof*

A sunroof to allows light in the cabin for a pleasant and comfortable ride for all.

06 USB Type-A and C Power Ports (Front and Rear)*

USB charging ports are available for both front and rear seat passengers, increasing convenience for everyone.

07 8-way Power Passenger's Seat*

The 8-way power seat provides the front passenger with a comfort and a stress-free ride, even on long trips. A seat lifter, electronic front tilt, front/rear slide, and recline adjustments provide 8-way adjustment capability.

08 Multi View Monitor*

Images from four cameras mounted on the front grille, door mirrors, and rear gate are displayed on the 11.6-inch centre display to help check blind spots at intersections with poor visibility, when pulling over to the side of the road, or when parking. Images are combined to create a 360-degree bird's-eye view, allowing the driver to check hard-to-see areas around the vehicle in real-time.

* Optional.

EXTERIOR COLOURS

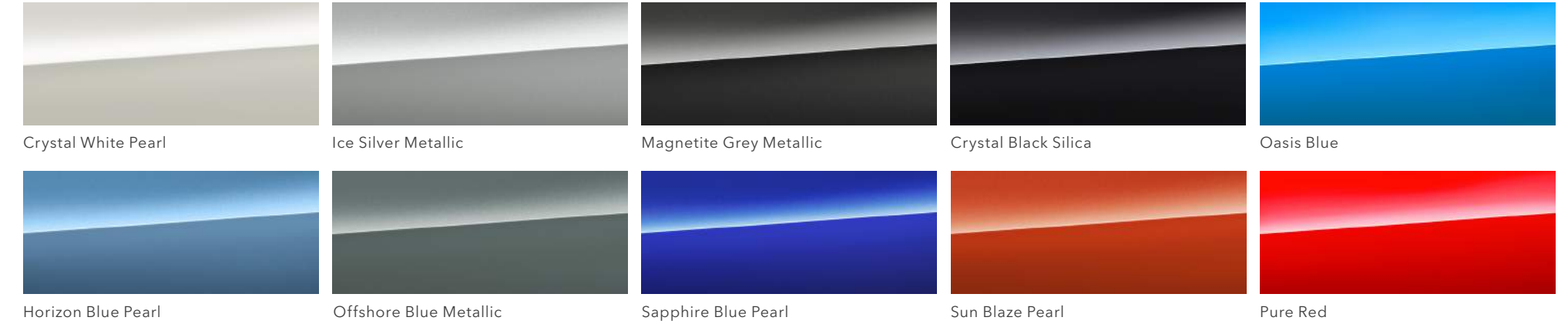

SEAT MATERIALS

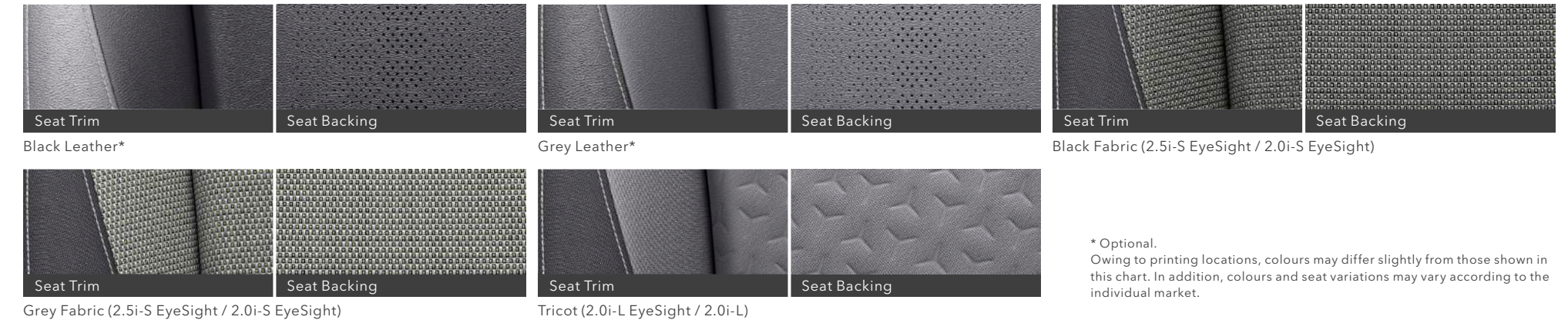

* Optional.
Owing to printing locations, colours may differ slightly from those shown in this chart. In addition, colours and seat variations may vary according to the individual market.

DIMENSIONS

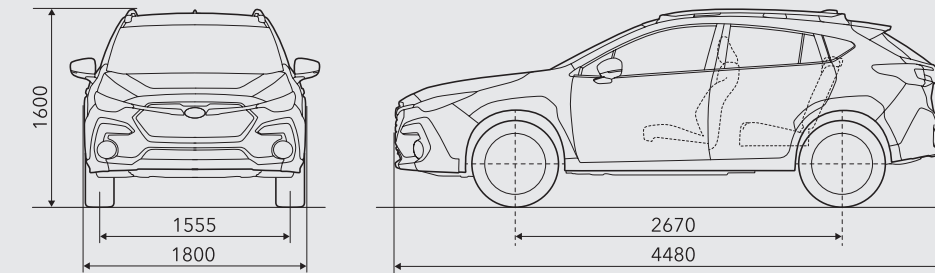

Dimensions are measured in accordance with standard measurement of SUBARU CORPORATION.

Not all features, options, or packages are available for all models and regions. See your specification sheet for availability. Please contact your local authorised Subaru retailer for more details.

SUBARU CORPORATION reserves the right to alter specifications and equipment without notice. Details of specifications, equipment, colour availability and lineup are subject to suit local conditions and requirements. Please inquire at your local retailer for details of any changes that might be required for your area.

